

# STILE INCONFONDIBILE



Vittorio Gassman

2018

**VIVERE  
IL FUORI**

**VIVERE  
IL FUORI**

MANIFATTURA PERGOLE VERANDE TETTOIE

PRODUZIONE E INSTALLAZIONE CHIAVI IN MANO.

## **AI PERMESSI , CI PENSIAMO NOI**

Le soluzioni che progettiamo sono tutte personalizzate.

Per questo abbiamo voluto *Vittorio Gassman* in copertina come simbolo di unicità, semplicità, eleganza, sobrietà, determinazione e stile.

Mettiamo tutta la passione affinché la tua veranda sia interpretata sulla personalità di chi la vive e sia inserita armonicamente nel contesto in cui viene posizionata: che sia unica.

Unica per stile e unica per prestazioni.

Mettiamo tutta l'esperienza di trent'anni per fornire soluzioni efficaci agli agenti atmosferici, facili da mantenere, belle da vedere.

Paolo Conforti

**PERGOLATI  
TETTOIE  
SERRE SOLARI  
GAZEBO  
CHIUSURE  
COPERTURE  
COMPLEMENTI**







# Mediterraneo Bio

DINAMIC - CLASSIC - INTEGRATA

Struttura: Alluminio

Copertura: Pale alluminio 160-210 mm

Tipo Copertura: Orientabile 90°-135°

Chiusure laterali: Panoramiche tutto vetro, scorrevoli, tende filtranti antivento

Finiture: Alluminio laccato opaco a polveri RAL a scelta

Scarico acqua: integrata nei piantoni

Resistenza la vento: fino a 90 Km/h a lame chiuse

Carico neve: da 35 a 120 Kg/mq

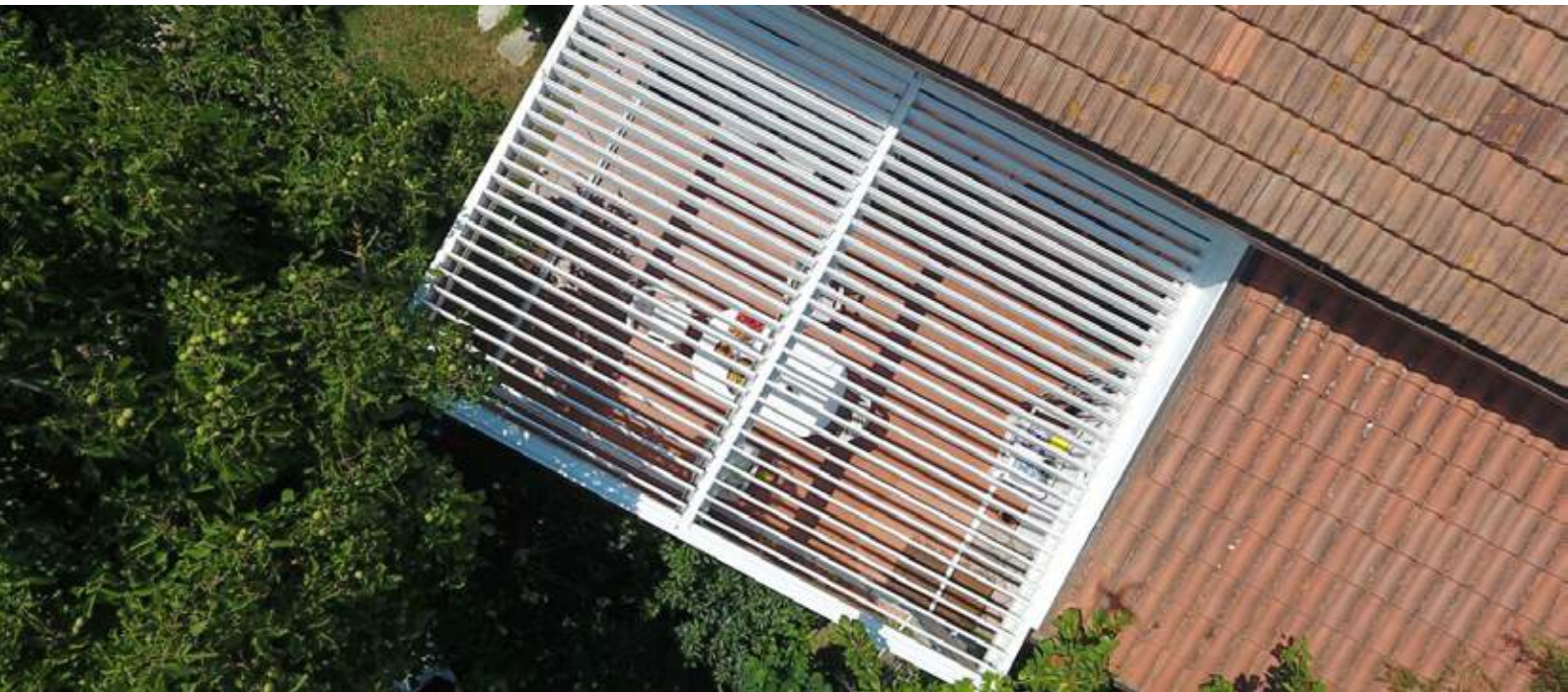

**Struttura ALLUMINIO/LEGNO**  
**PIANA APRIBILE**

AUTOPORTANTE  
ADDOSSATA

**MEDITERRANEO Bio**

Configurazioni

TETTOIA

GAZEBO

VERANDA

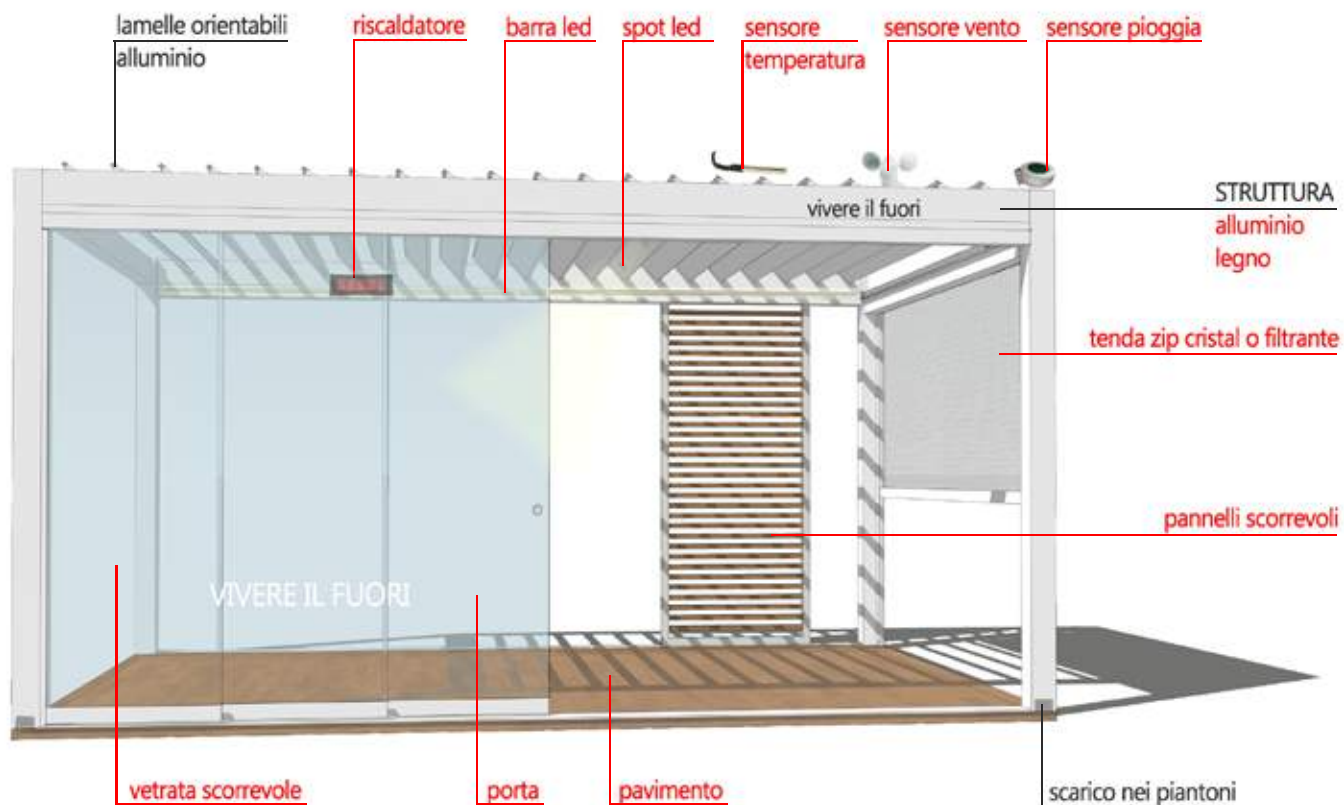

Inquadramento "ediizio" PERGOLATO / GAZEBO / SERRA SOLARE / TETTOIA





Castiglioncello (LI)



DINAMIC 190  
Autoportante 4 colonne

VIVERE  
IL FUORI

**VIVERE  
IL FUORI**

**Mediterraneo Bio**



CLASSIC  
2 campate 2 colonne







Livorno

**VIVERE  
IL FUORI**

**Mediterraneo Bio**

CLASSIC  
Addossata







**VIVERE  
IL FUORI**

**Mediterraneo Bio**





**INTEGRATA**  
Autoportante 4 colonne





Bibbona (LI)

**VIVERE  
IL FUORI**

**Mediterraneo Bio**



Castiglioncello (LI)

**DINAMIC 190**  
2 campate 3 colonne







Poveromo (MS)

DINAMIC 163  
Gazebo Autoportante 4 colonne



**VIVERE  
IL FUORI**

**Mediterraneo Bio**



lamelle parallele alla parete



 Pontedera (PI)



**DINAMIC 163**  
Addossata 2 campate 2 colonne

**VIVERE  
IL FUORI**

**Mediterraneo Bio**





Montecarlo (LU)

**DINAMIC 190**

Addossata 2 campate 2 colonne  
lamelle parallele alla parete





 Pomaia (PI)

CLASSIC

Addossata 2 colonne  
lamelle perpendicolari alla parete



**VIVERE  
IL FUORI**

**Mediterraneo Bio**







Suvereto (LI)

GAZEBO in ferro  
con lamelle integrate

**VIVERE  
IL FUORI**

**Mediterraneo Bio**









INTEGRATA autoportante

**VIVERE  
IL FUORI**

**Mediterraneo Bio**

 Rosignano Solvay (LI)

**DINAMIC 163**  
2 campate 2 colonne





CLASSIC  
inserita in struttura in legno lamellare



**VIVERE  
IL FUORI**

**Mediterraneo Bio**





Pontedera (PI)

DINAMIC 163

Addossata 2 campate 2 colonne







VIVERE  
IL FUORI

**VIVERE  
IL FUORI**

**Mediterraneo Bio**

 Bagnai - Isola d'Elba (LI)







Suvereto (LI)



**VIVERE  
IL FUORI**

**Mediterraneo Bio**

Aperta



Chiusa



Le pergole bioclimatiche possono essere inserite in una struttura esistente oppure installate sul sistema autoportante o addossato a muro, che comprende lo smaltimento dell'acqua nei piantoni. Le lamelle in alluminio sono dotate di un sistema di orientamento a motore che permette di posizionare le lamelle in qualsiasi angolazione: da completamente chiuse fino a 135°.

COLORI della STRUTTURA  
verniciatura a polvere in tutti i colori RAL. I più scelti:

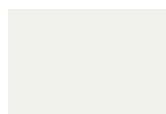

RAL 9010



RAL 1013



RAL 1015



RAL 7016



RAL 8019

scegli il tuo abbinamento bicolore

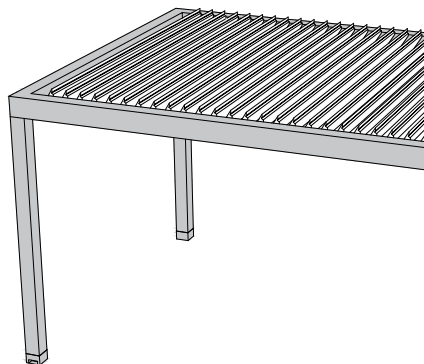

**VIVERE  
IL FUORI**

**Mediterraneo Bio**

# DINAMIC

lamella 163 mm

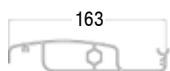

lamella 193 mm

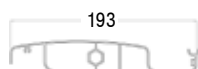

piantone

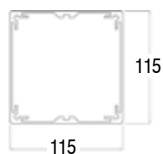

gronda

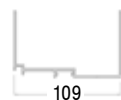

# CLASSIC

lamella

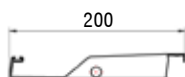

piantone

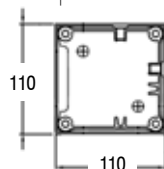

gronda

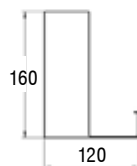

# INTEGRATA

lamella



piantone

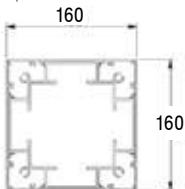

gronda

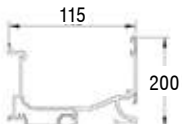





Caldo

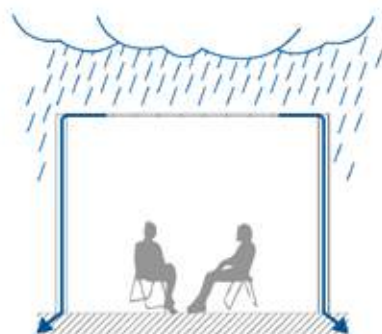

Pioggia



Vento



Neve

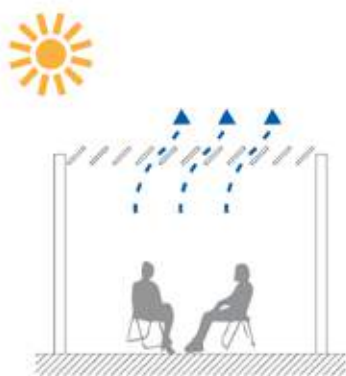

**VIVERE  
IL FUORI**

**Mediterraneo Bio**

## Scarico acqua

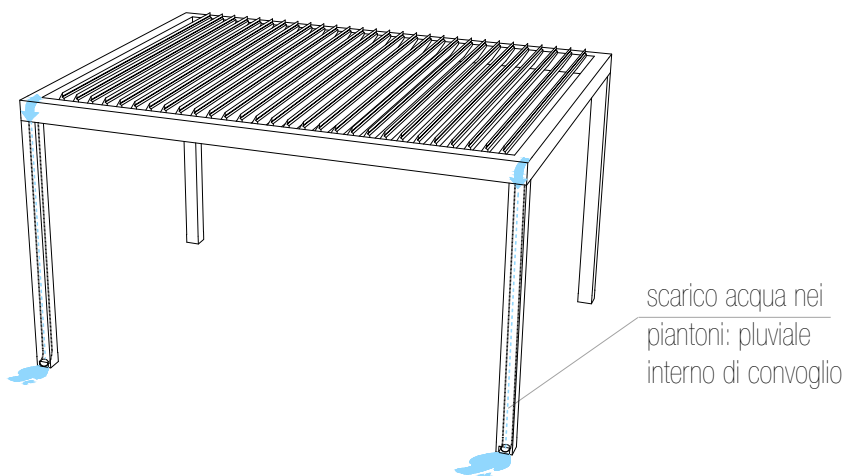

## Opzione allungamento pluviale

lastricati solari

terrazzi

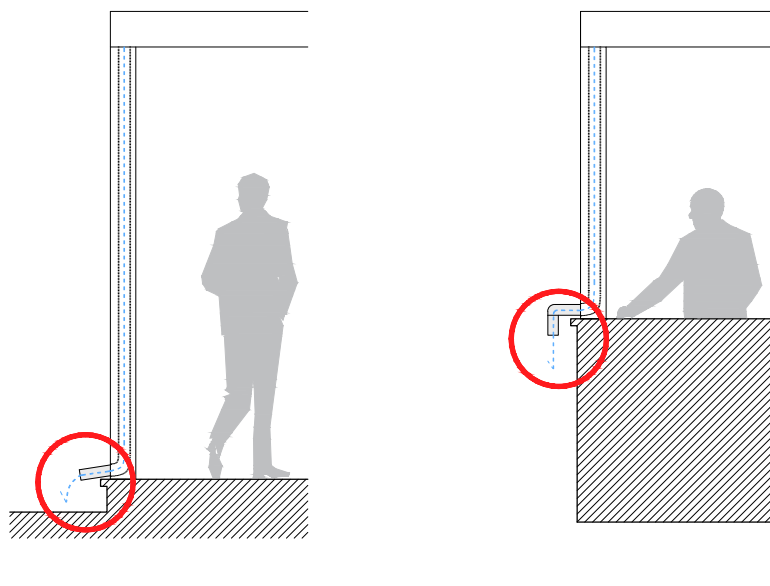



## Tenda motorizzata con cassonetto

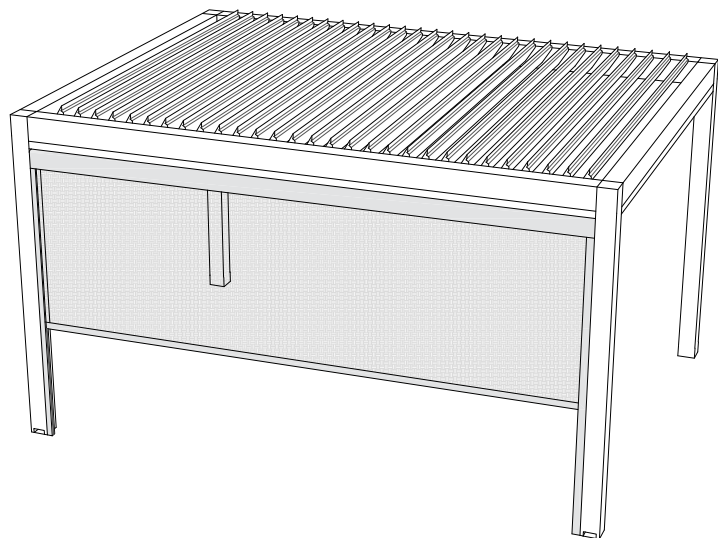

DINAMIC

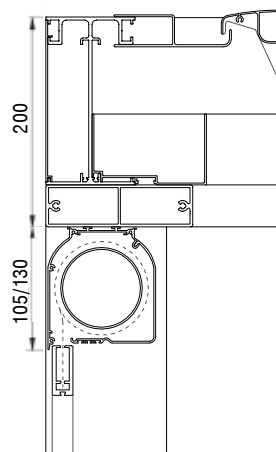

INTEGRATA

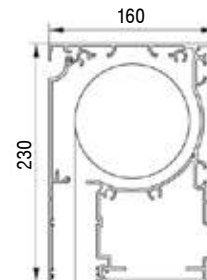

## Vetrare scorrevoli

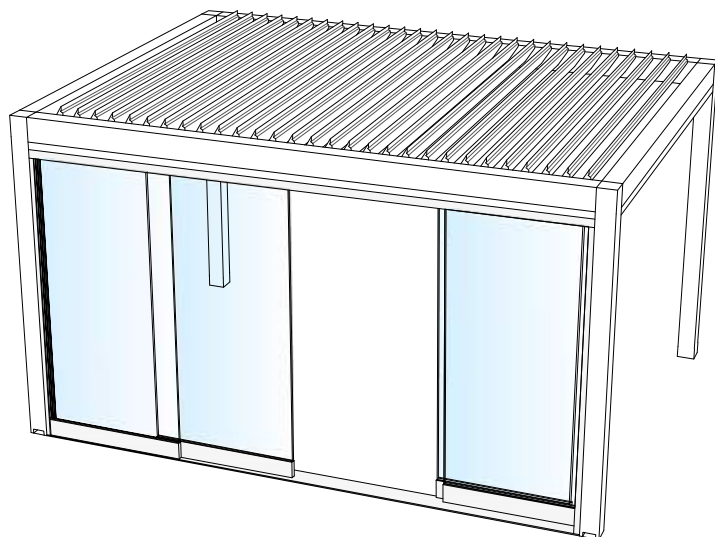

DINAMIC

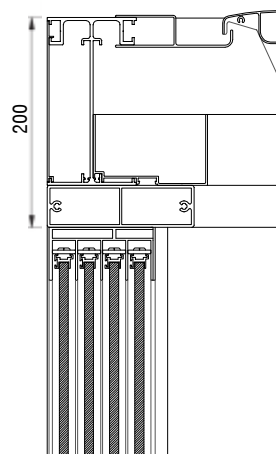

**VIVERE  
IL FUORI**

**Mediterraneo Bio**

Struttura: Legno/Alluminio

Copertura: Sandwich

Tipo Copertura: Fissa Inclinata

Chiusure laterali: Panoramiche tutto vetro, scorrevoli taglio termico

Vetri: Temperato 10 mm - Camera

Finiture: Legno sbiancato naturale

Scarico acqua: Gronda integrata nella fascia perimetrale



# Mediterraneo Shed

**VIVERE  
IL FUORI**



**Struttura ALLUMINIO/LEGNO**  
**PIANA FISSA**

AUTOPORTANTE  
ADDOSSATA

**MEDITERRANEO Shed**

Configurazioni  
TETTOIA  
VERANDA

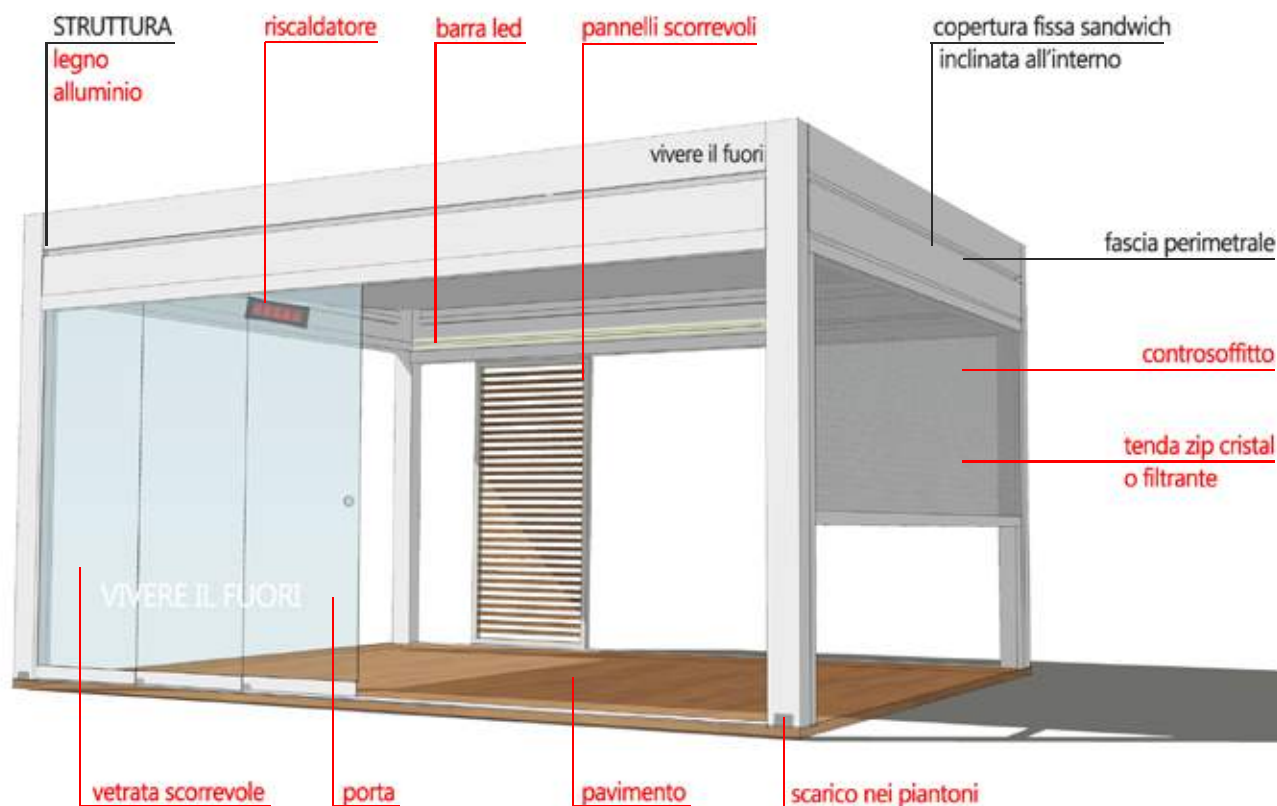

Inquadramento "ediizio" GAZEBO / SERRA SOLARE / TETTOIA



**Mediterraneo Shed**



 Bibbona (LI)



Fascia perimetrale legno

discendente esterno

discendente esterno

**VIVERE  
IL FUORI**

**Mediterraneo Shed**



San Vincenzo (LI)

Fascia perimetrale  
in alluminio

Struttura in alluminio



Colonna con scarico  
acqua interno



Interno con  
pannello sandwich



**VIVERE  
IL FUORI**

**Mediterraneo Shed**







**VIVERE  
IL FUORI**

**Mediterraneo Shed**





Principina a Mare (GR)

Fascia perimetrale  
integrata con bioclimatica

Pannello sandwich  
80 mm alluminio

**VIVERE  
IL FUORI**

**Mediterraneo Shed**



Struttura in alluminio



Porta ingresso  
battente 2 ante

GAZEBO AUTOPORTANTE



**VIVERE  
IL FUORI**

**Mediterraneo Shed**



Principina a Mare (GR)

Porta di sicurezza





Chiusure scorrevoli taglio termico

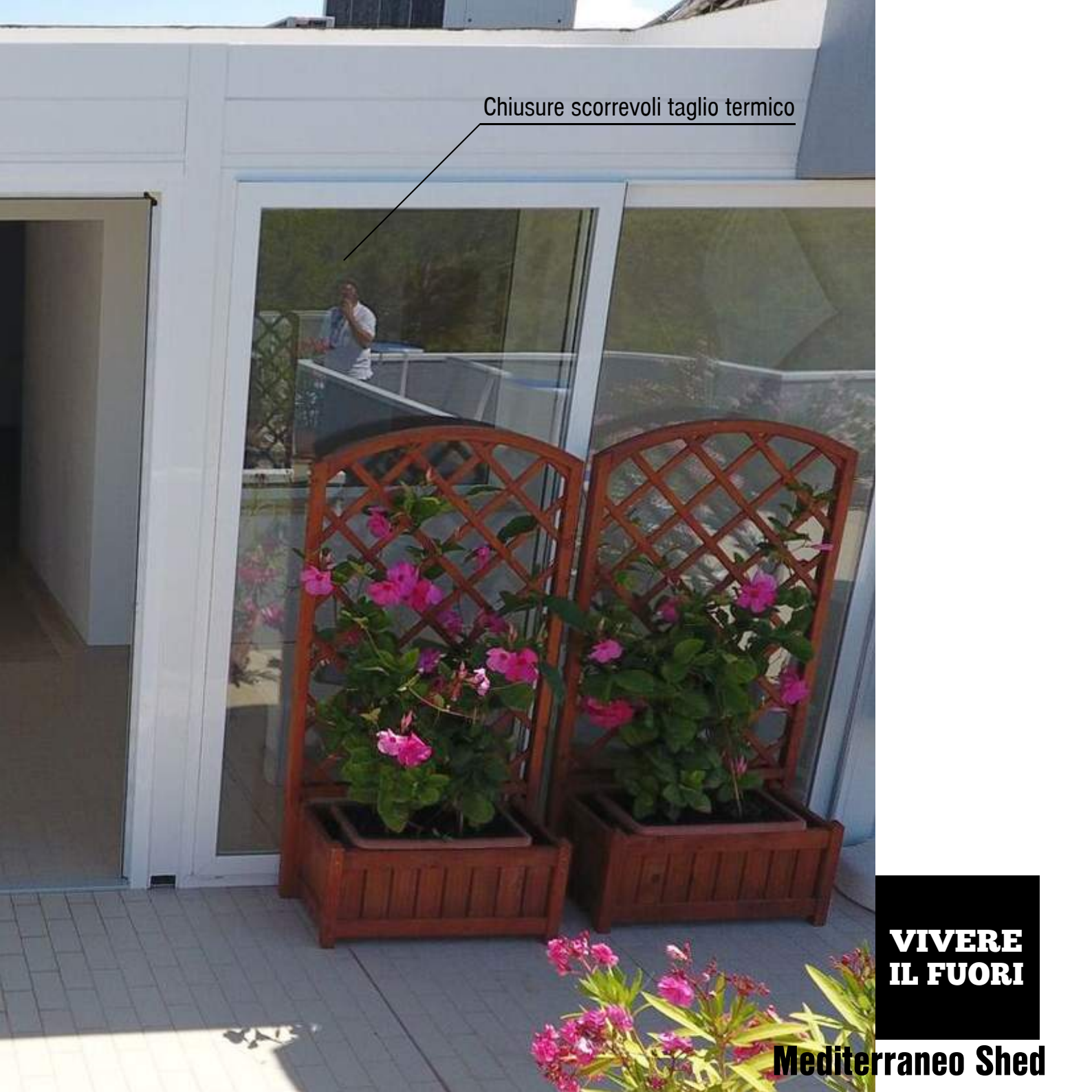

**VIVERE  
IL FUORI**

**Mediterraneo Shed**

 Bibbona (LI)

Controsoffitto  
sbiancato in legno





Opzione fascia  
perimetrale classica



Piastre per legno



Particolare costruttivo  
fascia alluminio

**VIVERE  
IL FUORI**

**Mediterraneo Shed**



# Progetto esecutivo

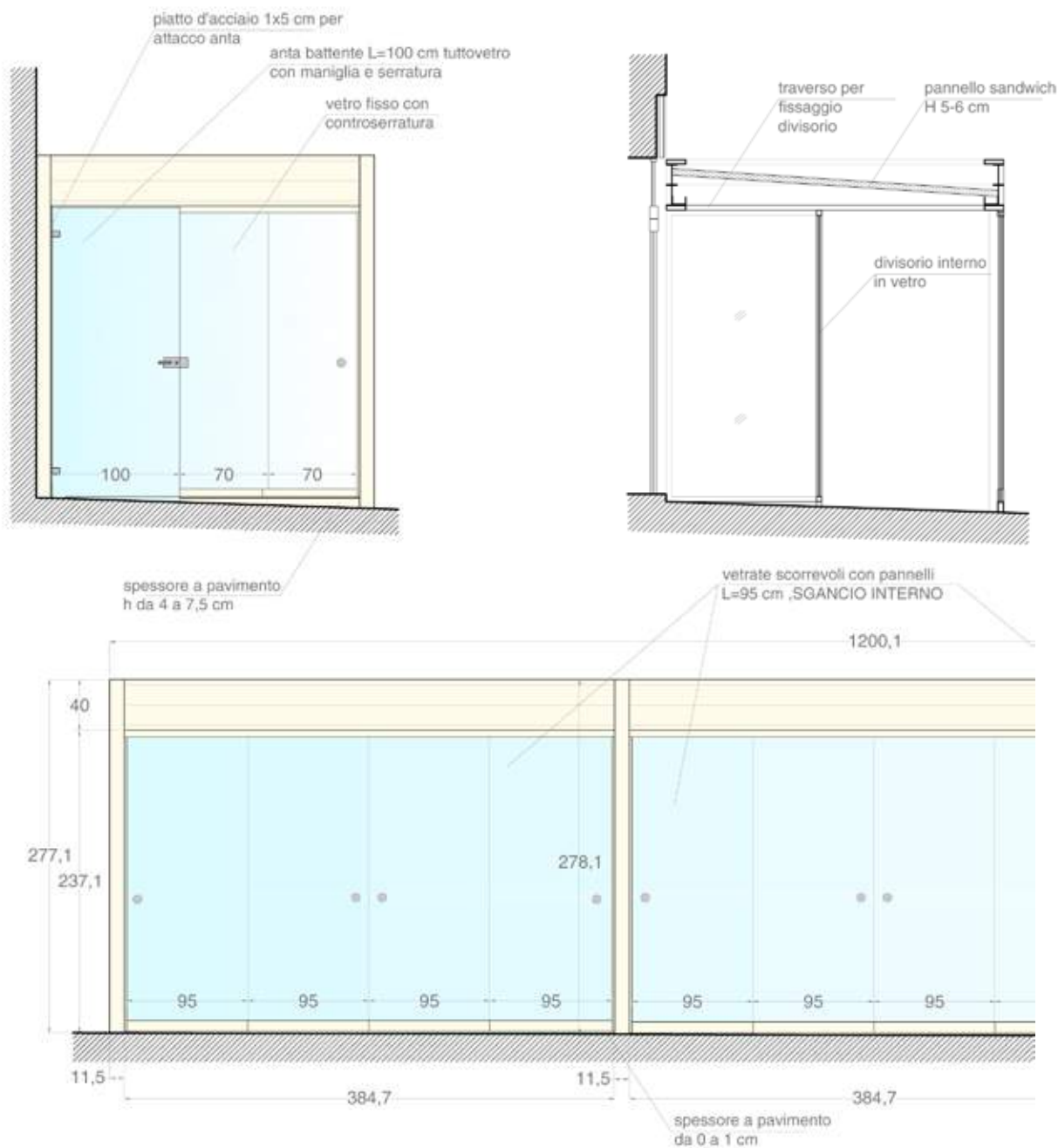



**VIVERE  
IL FUORI**

**Mediterraneo Shed**

# Mediterraneo Pack

Struttura: Alluminio o Legno

Copertura: Telo NOT CLEAN triplo strato mano tessile

Tipo Copertura: Apribile - Inclinata 15%

Apertura: Motorizzata con telecomando

Chiusure laterali: Panoramiche tutto vetro, Tende Grandangolo, Scorrevoli

Finiture: Alluminio laccato a polveri RAL a scelta

Scarico acqua: integrata nei piantoni

**VIVERE  
IL FUORI**



**Struttura ALLUMINIO  
PIANA APRIBILE**

AUTOPORTANTE  
ADDOSSATA

**MEDITERRANEO Pack**

Configurazioni  
GAZEBO  
PERGOLA

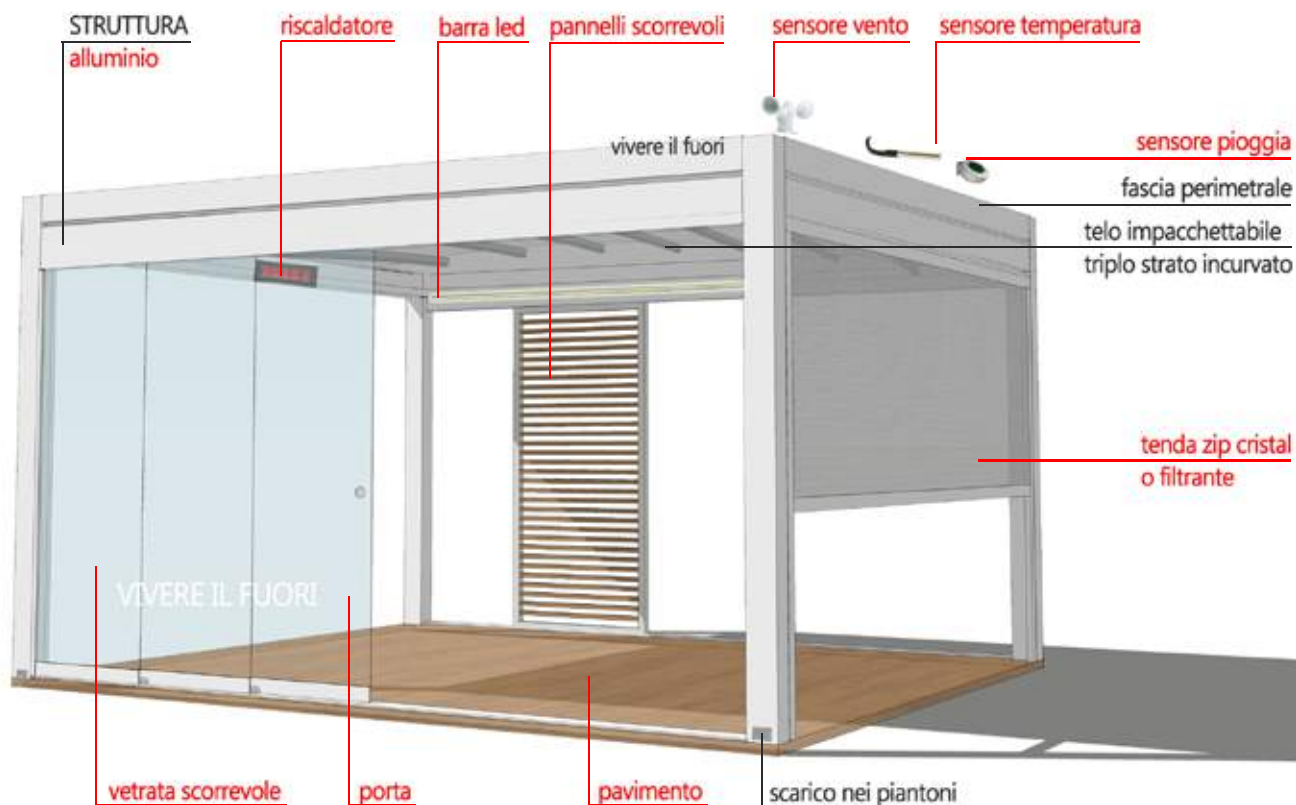

Inquadramento "ediizio" TENDA / GAZEBO





Firenze

copertura piana con telo impermeabile  
e tende trasparenti anti pioggia

**VIVERE  
IL FUORI**

**Mediterraneo Pack**









**VIVERE  
IL FUORI**

**Mediterraneo Pack**



# Inverno

telo Not Clean





# Estate

chiusure tuttovetro



Cecina (LI)

**VIVERE  
IL FUORI**

**Mediterraneo Pack**







 Camaiore (LU)

**VIVERE  
IL FUORI**

**Mediterraneo Pack**





autoportante





Poggibonsi (SI)

copertura apribile telo Not Clean



**VIVERE  
IL FUORI**

**Mediterraneo Pack**









**VIVERE  
IL FUORI**

**Mediterraneo Pack**

 Porto Santo Stefano (GR)







**VIVERE  
IL FUORI**

**Mediterraneo Pack**



# Sit-in Shed

## Copertura

Struttura: Legno/Alluminio

Copertura: Pannello Sandwich - Vetro 4.4.2 - Policarbonato

Tipo Copertura: Fissa o Apribile - Inclinata 15%

Chiusure laterali: Panoramiche tutto vetro, Tende Grandangolo - Scorrevoli

Finiture: Alluminio laccato a polveri RAL a scelta - Legno sbiancato naturale

Scarico acqua: laterale/integrato nei piantoni

**VIVERE  
IL FUORI**



**Struttura LEGNO/ALLUMINIO  
INCLINATA FISSA**

ADDOSSATA

**SIT-in Shed**

Configurazioni

TETTO

VERANDA

TETTOIA

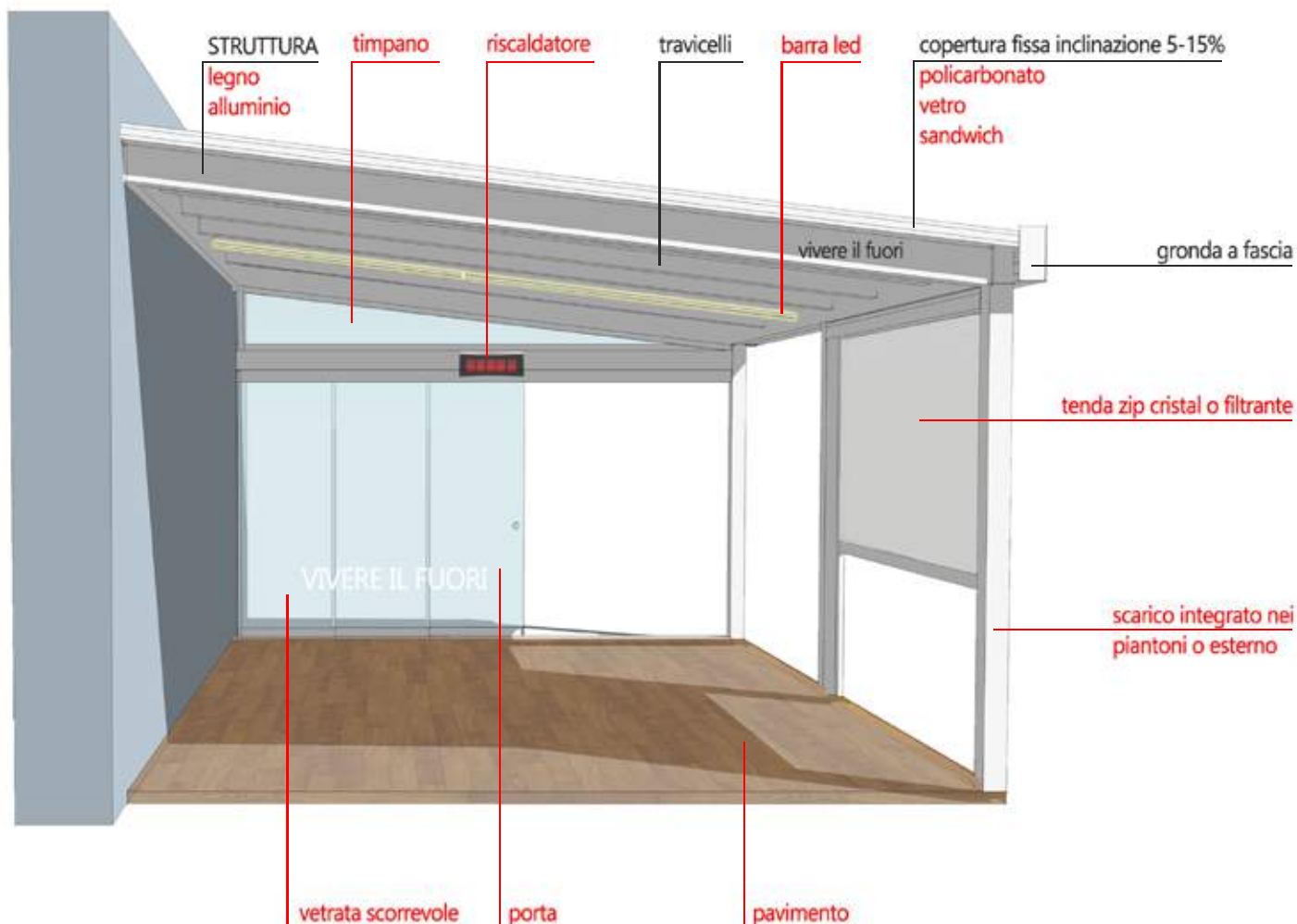

Inquadratura "ediizio" TETTOIA / SERRA SOLARE





 Follonica (GR)

pannello coibentato

**VIVERE  
IL FUORI**

**Sit-in Shed**









**VIVERE  
IL FUORI**

**Sit-in Shed**



policarbonato



gronda



Viareggio (LU)

pendenza 15%

**VIVERE  
IL FUORI**

**Sit-in Shed**

Chiusure trasparenti antivento



Struttura in legno con tetto fisso



 Riomaggiore (SP)

Struttura in legno e ferro  
con tetto fisso e chiusure  
panoramiche in vetro



**VIVERE  
IL FUORI**

**Sit-in Shed**



Aulla (MS)

timpano in vetro





struttura alluminio



**VIVERE  
IL FUORI**

**Sit-in Shed**









Lama Mocogno (MO)

VERANDA con serramenti scorrevoli

**VIVERE  
IL FUORI**

**Sit-in Shed**







 Pescia (PT)



**VIVERE  
IL FUORI**

**Sit-in Shed**









SERRA con pannelli solari integrati

**VIVERE  
IL FUORI**

**Sit-in Shed**

# Sit-in Pack

## TENDA A PERGOLA

Struttura: Alluminio o Legno

Copertura: Telo NOT CLEAN triplo strato mano tessile

Tipo Copertura: Apribile - Inclinata 15%

Apertura: Motorizzata con telecomando

Chiusure laterali: Panoramiche tutto vetro, Tende Grandangolo, Scorrevoli

Finiture: Alluminio laccato a polveri RAL a scelta

Scarico acqua: integrata nei piantoni

**VIVERE  
IL FUORI**



**Struttura LEGNO/ALLUMINIO  
INCLINATA APRIBILE**

ADDOSSATA

**SIT-in Pack**

Configurazioni  
PERGOLA

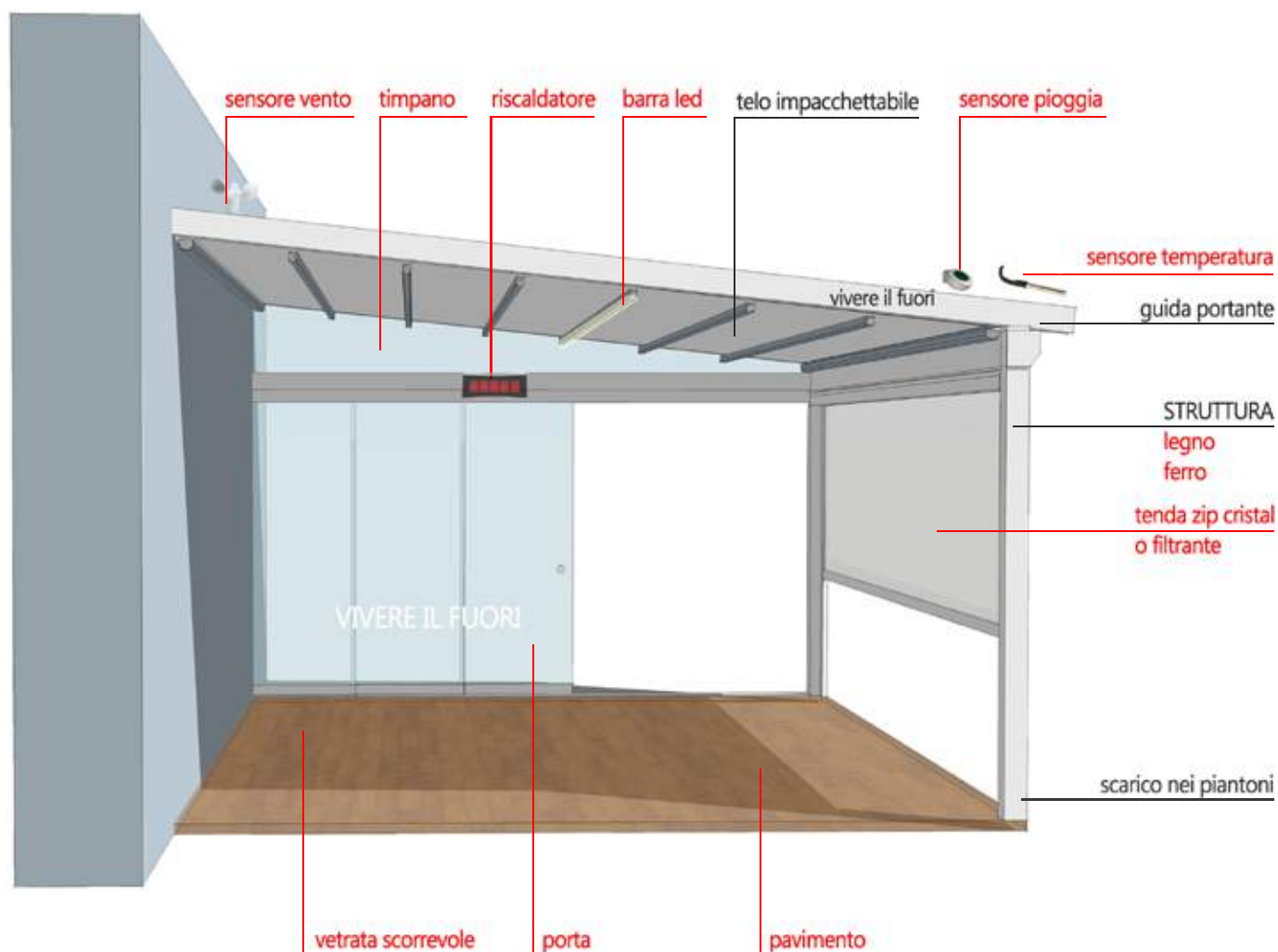

Inquadramento "ediizio" TENDA

 Prato







**VIVERE  
IL FUORI**

**Sit-in Pack**



Cecina (LI)







**VIVERE  
IL FUORI**

**Sit-in Pack**

 Ponsacco (PI)





 Scandicci (FI)



**VIVERE  
IL FUORI**

**Sit-in Pack**



 Castiglioncello (LI)





 Colle Val d'Elsa (SI)



**VIVERE  
IL FUORI**

**Sit-in Pack**

Aperta



Chiusa



Struttura portante in alluminio con telo triplo strato rinforzato da frangivento longitudinali. Sistema impacchettabile resistente alla pioggia e al vento con movimentazione a motore e sensori pioggia - sole - vento.



TESSUTI

STAM



OPATEX



COLORI



# NOT Clean

Teli oscuranti mano tessile nella parte interna.  
La struttura del tessuto a tre strati permette di  
vedere sempre il telo pulito nella parte sottostante.

**VIVERE  
IL FUORI**

**Sit-in Pack**

 Scandicci (FI)

# Soffio Shed

## TETTOIA IN FERRO

Struttura: Ferro

Copertura: Telo in pvc - Pannello sandwich

Tipo Copertura: Fissa - Inclinata all'interno

Chiusure laterali: Panoramiche tutto vetro, Tende Grandangolo, Scorrevoli

Finiture: RAL a scelta

Scarico acqua: integrata nei piantoni

**VIVERE  
IL FUORI**



**Struttura FERRO  
PIANA FISSA**

Configurazioni  
TETTOIA  
VERANDA

AUTOPORTANTE  
ADDOSSATA

**SOFFIO Shed**

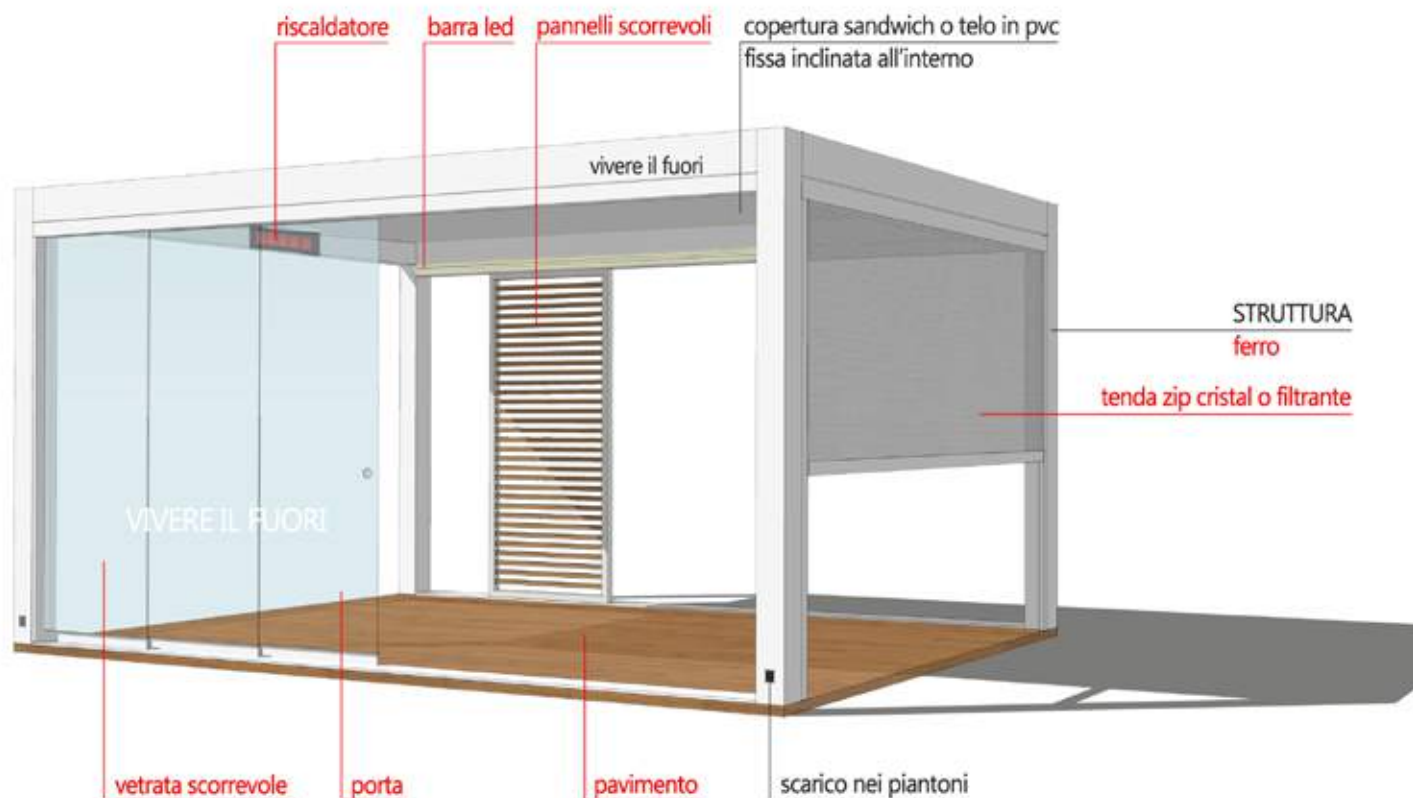



Bagno a Ripoli (FI)



copertura con pannello sandwich



 Pontremoli (MS)

copertura contelo impermeabile



**VIVERE  
IL FUORI**  
**Soffio Shed**

# Soffio Pack

Struttura: Ferro

Copertura: Telo in pvc

Tipo Copertura: Apribile

Chiusure laterali: Panoramiche tutto vetro, Tende Grandangolo, Scorrevoli

Finiture: RAL a scelta

Scarico acqua: laterale



**VIVERE  
IL FUORI**



**Struttura FERRO  
PIANA APRIBILE**

AUTOPORTANTE  
ADDOSSATA

**SOFFIO Pack**

Configurazioni  
TENDA  
GAZEBO



Inquadramento "ediizio" TENDA / GAZEBO

 Casale Marittimo (PI)





 Empoli (FI)



**VIVERE  
IL FUORI**

**Soffio Pack**



Rosignano Solvay (LI)

# Cielo

## Tenda a Vela

Struttura: Alluminio o Acciaio Inox

Copertura: Telo traspirante

Tipo Copertura: Fissa - Apribile

Finiture: Naturale

Resistenza al vento: 30 km/h

**VIVERE  
IL FUORI**





Cecina Mare (LI)

**VIVERE  
IL FUORI**

**Tenda a Vela Cieto**







**VIVERE  
IL FUORI**

**Tenda a Vela Cielo**

 Cecina Mare (LI)





 Rosignano Solvay (LI)



**VIVERE  
IL FUORI**

**Tenda a Vela Cielo**

# Lineare

Scorrevole tuttovetro

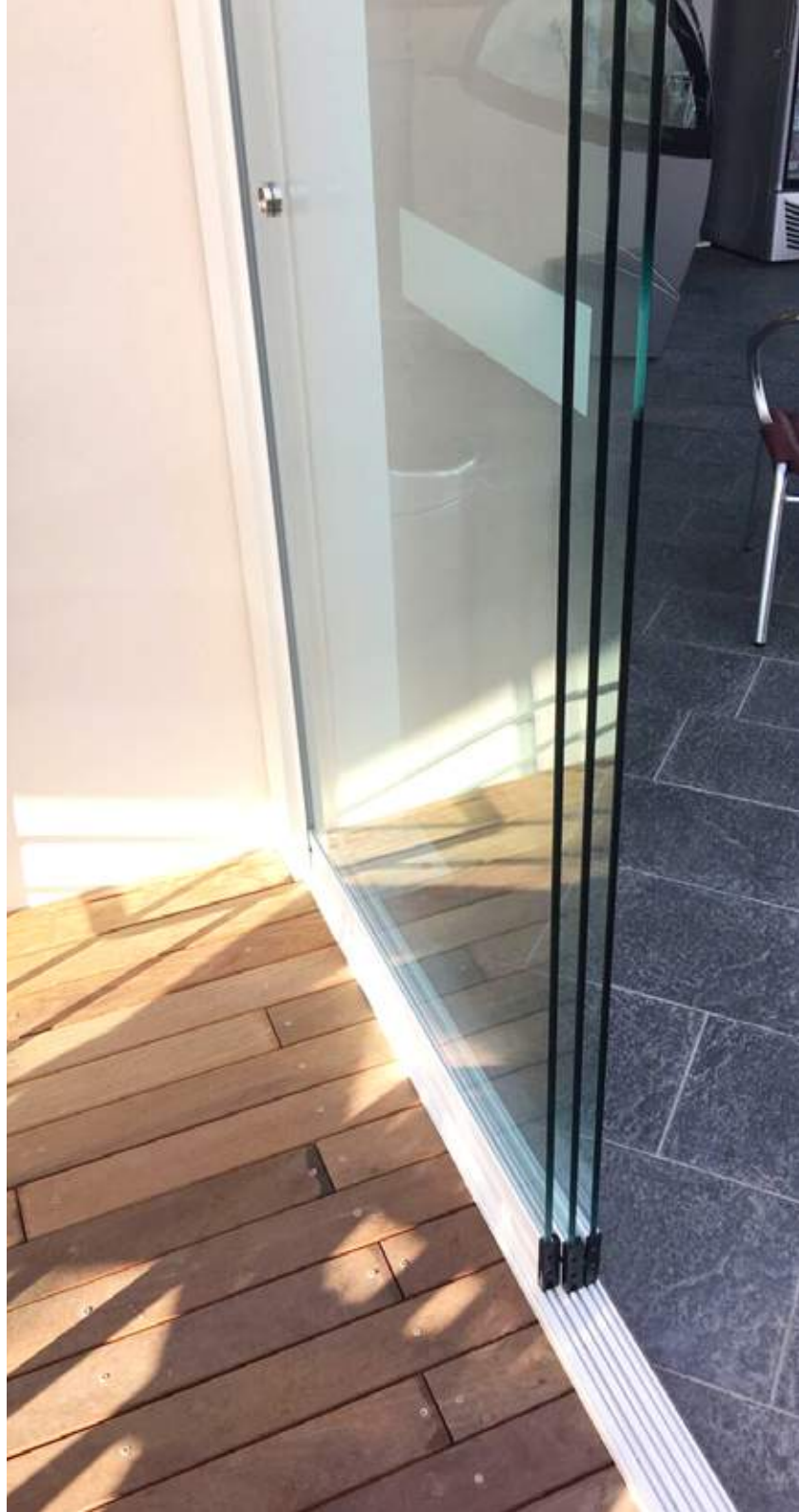



## Schema apertura - ingombro

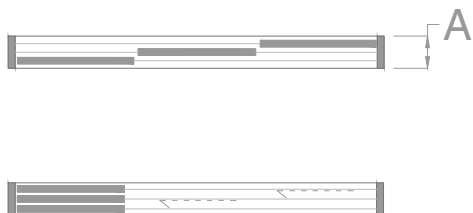

n° ante	A L guida
2 - 4	5 cm
3 - 6	7,5 cm
4	10 cm
5	12,4 cm

## Configurazioni possibili V.I.



## Dimensioni

Larghezza MAX vetrata	10 pannelli
Larghezza MAX pannello vetro	110 cm
Altezza MAX pannello vetro	280 cm
Altezza guida superiore	8 cm
Altezza pinza vetro inferiore	8,5 cm
Altezza spazzolino inferiore	0,5 cm

**VIVERE  
IL FUORI**







Rio nell'Elba (LI)

**VIVERE  
IL FUORI**





Grosseto







**VIVERE  
IL FUORI**

# Appesa

Impacchettabile e Scorrevole tuttovetro





## Schema apertura - ingombro

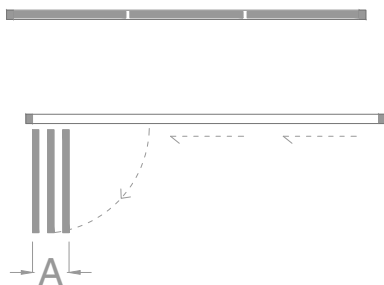

n° ante	A ingombro ante
1	4,5 cm
3	13,5 cm
4	18 cm
5	22,5 cm

## Configurazioni possibili V.I.

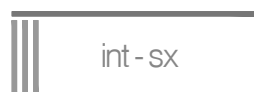

## Dimensioni

Larghezza MAX vetrata singola apertura laterale	6 pannelli - max 420 cm
Larghezza MAX pannello vetro	70 cm
Altezza MAX pannello vetro	290 cm
Altezza compensatore superiore	6 cm
Altezza guida superiore	6 cm
Altezza pinza su vetro superiore e inferiore	4,5 cm
Altezza spazzolino inferiore	0,5 cm

**VIVERE  
IL FUORI**



Follonica (GR)

impacchettamento esterno







senza guida a terra

**VIVERE  
IL FUORI**





porta tuttovetro con  
maniglia e serratura



finiture in verde

**VIVERE  
IL FUORI**



# Minimal

## Scorrevole

Telaio: incassato nel pavimento e soffitto

Tecnologia: 8 ruote acciaio inox ogni anta

Peso anta: da 400 a 800 kg

Abbattimento acustico: fino a 39 Db

Resistenza all'effrazione: ENV 1627

Resistenza alla pioggia battente: EN12208 - Classe 7A

Permeabilità all'aria: EN12207 - Classe 4

128 Trasmissione termica: da 0,7 a 1,7 W/mqK





scorrevole

## Dimensioni

Larghezza MAX vetrata	420 cm
Superficie MAX pannello vetro	12 cm
Altezza MAX pannello vetro	300 cm
Larghezza minima profilo incontro	24 cm
Spessore vetro	30-36 mm

**VIVERE  
IL FUORI**



profilo verticale 3,5 cm





**VIVERE  
IL FUORI**

# Quadro

Scorrevole con infisso







**VIVERE  
IL FUORI**

# Grandangolo

Chiusura arrotolabile trasparente







**VIVERE  
IL FUORI**

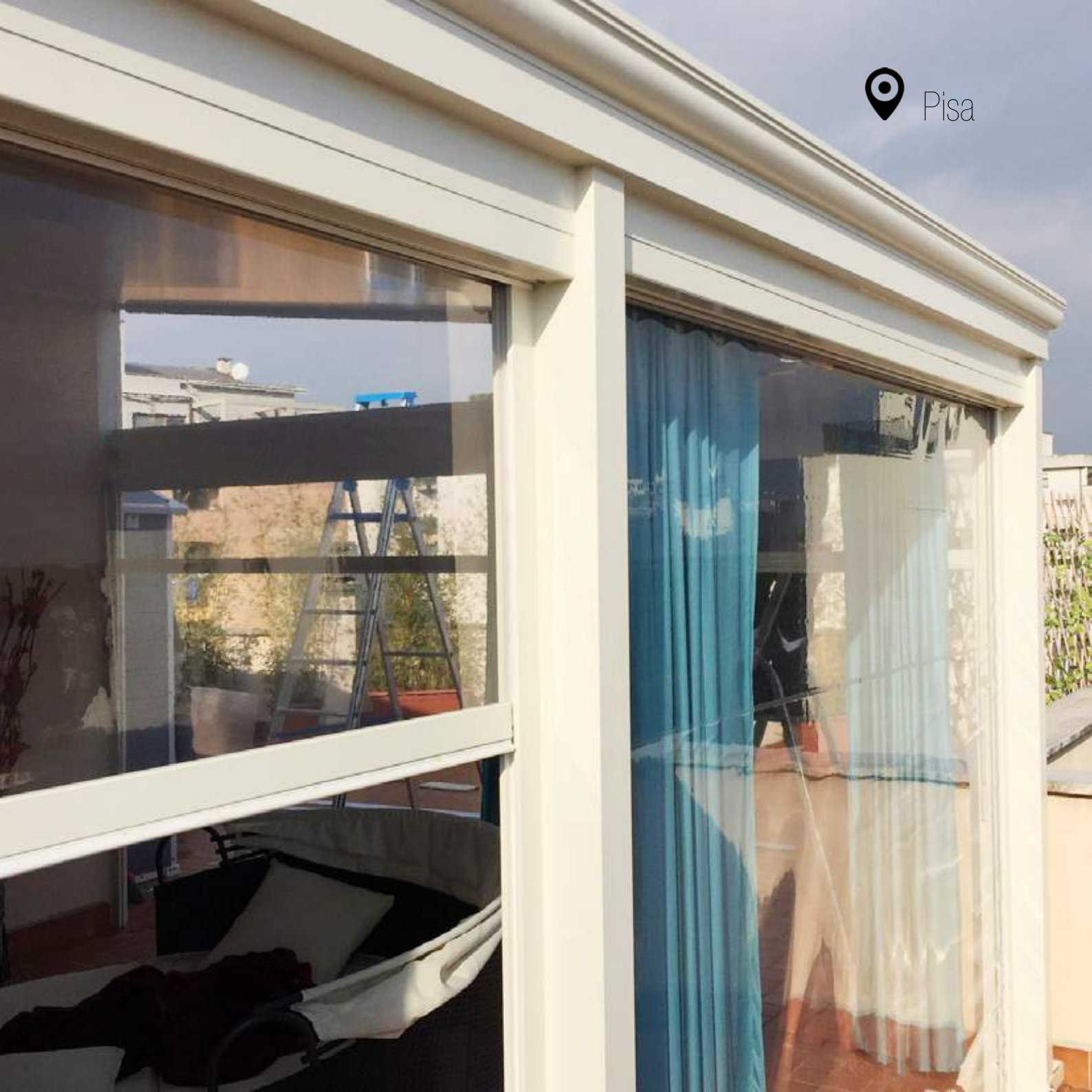





Seravezza (LU)

chiusura zip trasparente su  
Tettoia fissa in alluminio

**VIVERE  
IL FUORI**

# Fresco

Chiusura arrotolabile filtrante



filtrante

**VIVERE  
IL FUORI**





**VIVERE  
IL FUORI**



# Notte

Chiusura avvolgibile oscurante





# Frangisole

Pannelli scorrevoli su guide

**VIVERE  
IL FUORI**

# Pensiline

## Vetro

Tiranti: Inox

Barra: Alluminio

Vetro: 10+10 temperato

Profondità: 150 cm







**VIVERE  
IL FUORI**

EFFETTO LEGNO



EFFETTO PIETRA



# Grès monolitico

Misura: 40x40 - 50x50 cm - 40x120 cm - 50x100 cm

Caratteristiche: Carrabile Antiscivolo



# Angelim

Lunghezza: 100 - 460 cm +/-3%

Larghezza: 9 cm +/-3%

Finitura: Olio 2 mani a 72h una dall'altra ogni 6 mesi

Fissaggio: clip o viti

Fuga: 5 mm



invecchiamento

**VIVERE  
IL FUORI**



Legno vissuto







Bolgheri (LI)

**VIVERE  
IL FUORI**



# Ipe

Resistenza: 20 anni

Lunghezza: 95 - 210 cm

Larghezza: 95 - 100 - 140 mm

Fissaggio: clip o viti

Fuga: 5 mm

Finitura: Olio

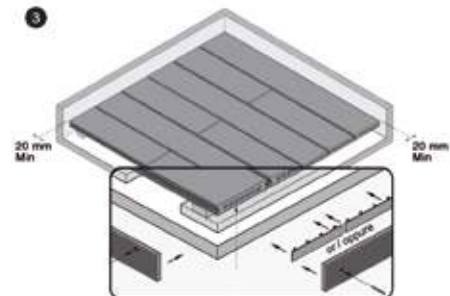
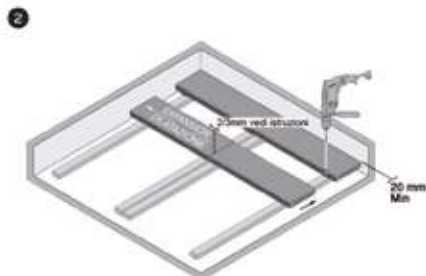
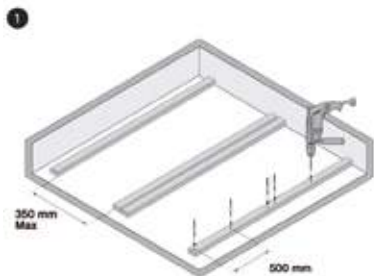





**VIVERE  
IL FUORI**







sottostruttura in larice pavimento lpe

**VIVERE  
IL FUORI**

# Decking

Legno composito

Resistenza: 25 anni

Lunghezza: 290 cm

Larghezza: 14,6 cm

Fissaggio: clip o viti

Fuga: 5 mm

Pulizia: spazzola o acqua a pressione da 30 cm e sapone neutro







**VIVERE  
IL FUORI**



led integrati nelle lamelle

# Led

Protezione: ip68

Lunghezza: Max 500 cm

Luce Calda: 2800 K doppia densità

Alimentatore: 12 V

Dimmer: 18 A

Telecomando: 4 zone

Ricevitore: 4 zone



led perimetrali



**VIVERE  
IL FUORI**



barra led 2 cm





**VIVERE  
IL FUORI**

# Riscaldatori

Lampade al tungsteno



Potenza: 2000/6000 W

Lunghezza: 1117/1410 mm

Altezza: 214 mm

Fissaggio: con staffa





bagliore a bassa intensità

**VIVERE  
IL FUORI**

# Noi







**VIVERE  
IL FUORI**

VIVERE IL FUORI

F. +39.0586.17.13.023

@ info@vivereilfuori.it

M. +39 349.460.1549 Paolo Conforti

W. www.vivereilfuori.it

---

MANIFATTURA PERGOLE VERANDE TETTOIE

---

homify 

f

  
houzz

in

g+